



INDUSTRIAL TOOL & SUPPLY COMPANY

# TANITIM BROŞÜRÜ

**AKILLI**  
FİYAT

**HIZLI**  
TESLİMAT



Toksan Dış Ticaret Ltd.Şti.

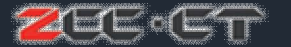

---

**Toksan Grup olarak**  
**20 yılı aşkın süredir kesici takım sektöründe**  
**Deneyimli ve teknik becerisi olan kadromuzla**  
**Çözüm Ortağınız Olduk!**

**ZCC-CT**

ile 35.000 den fazla kesici takım çeşidiyle

**C.P.T.**  
Precision Werkzeug

ile dış çekme ve şekillendirme hizmetlerinde,

**Neoboss**

ile Alman kalitesi kılavuz grubuyla,

**Yes**® YESTOOL Co., Ltd.

ile takma uçlu delik delme operasyonlarında;

**SİZLERE;**

**AKILLI**  
FİYAT

**HIZLI**  
TESLİMAT

**SUNMAKTAYIZ!**



INDUSTRIAL TOOL & SUPPLY COMPANY

# TOKSAN GRUP OLARAK

ZCC·CT

 **C.P.T.** GEWINDEWERKZEUGE

 **Neoboss**

 **Yes**® YESTOOL Co., Ltd.

4 DÜNYA MARKASININ DİSTRİBÜTÖRLÜĞÜNÜ,

 **EROGLU**  
Präzisionswerkzeuge

 **AKKO**®

DÜNYA MARKASI OLACAK 2 TÜRK FİRMASININ DA ANA BAYİLİĞİNİ  
YAPMAKTADIR.



Toksan Dış Ticaret Ltd.Şti.

ZCC·CT

# TOKSAN GRUP Türkiye Organizasyonu



# TOKSAN GRUP Türkiye Organizasyonu

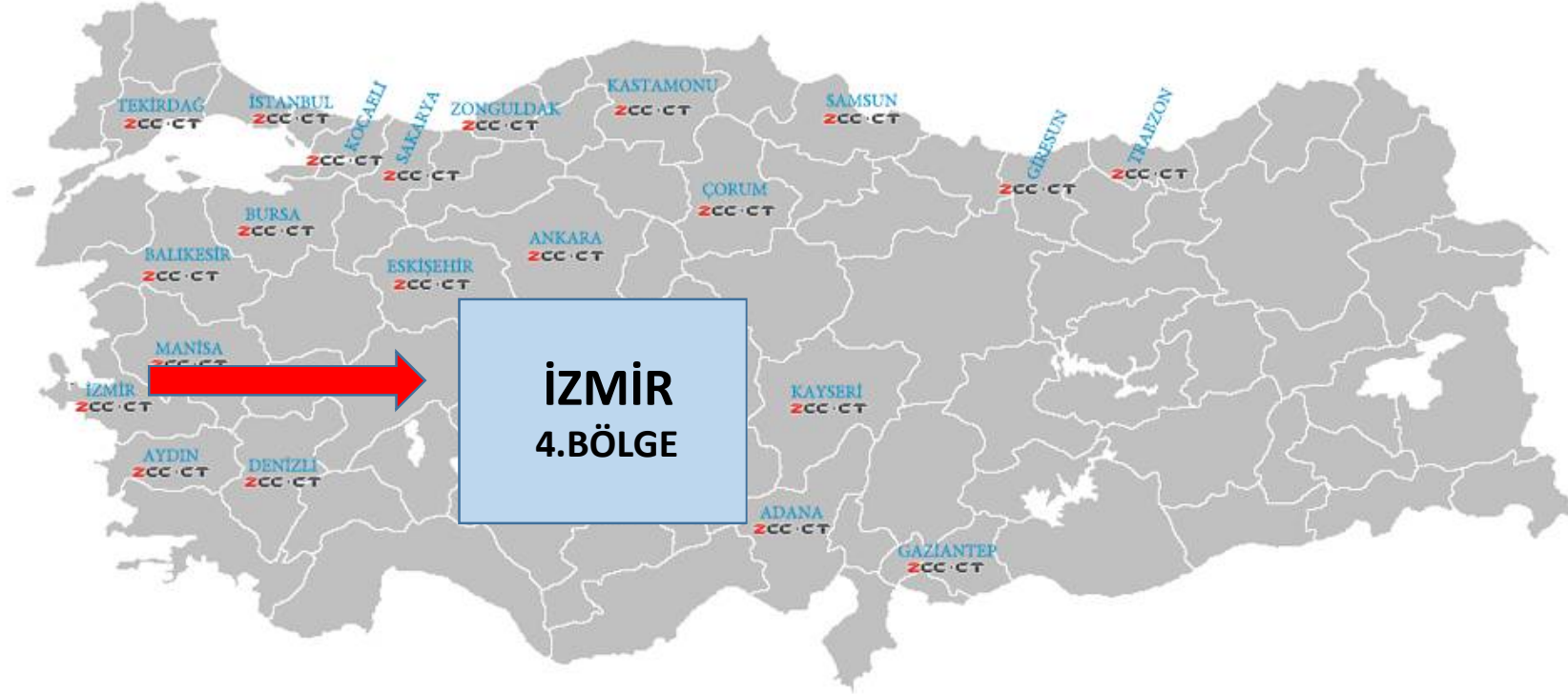

# TOKSAN GRUP Türkiye Organizasyonu

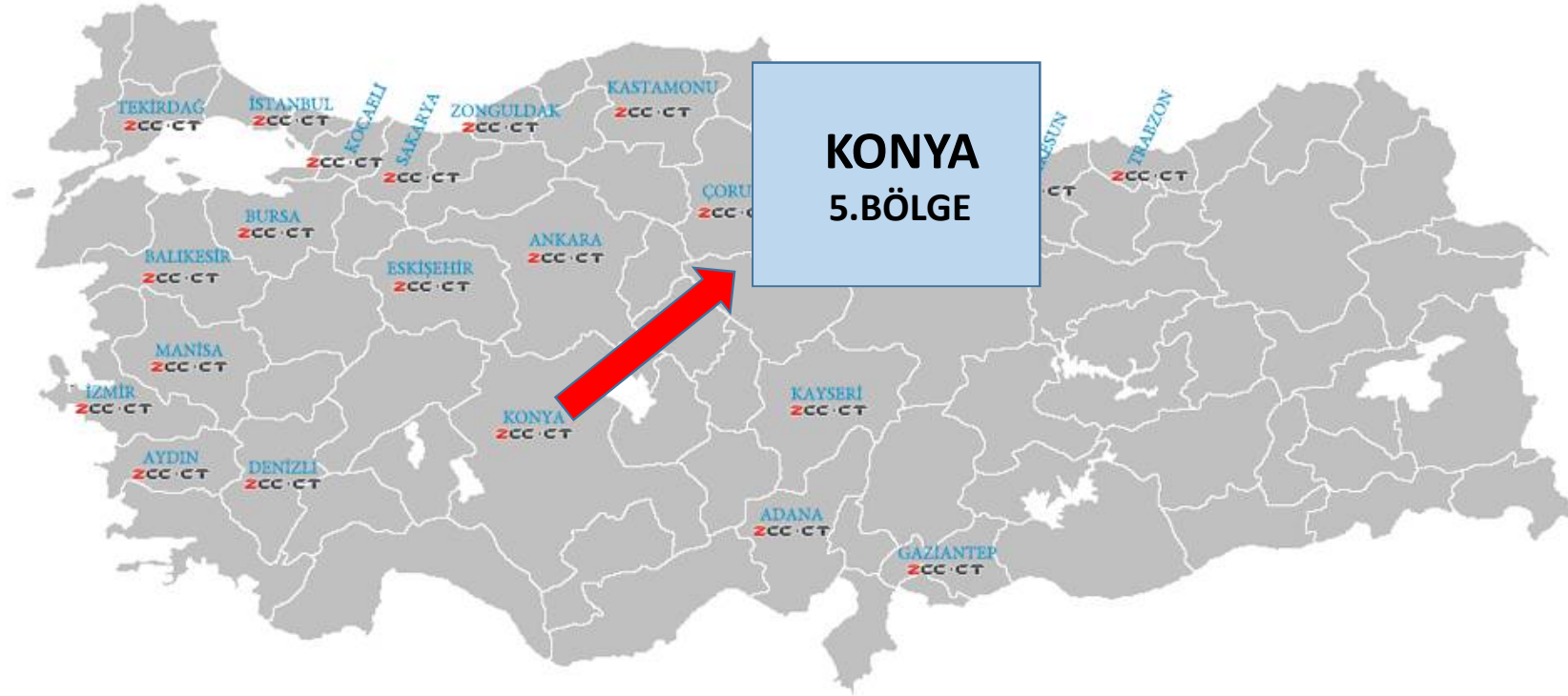

# TOKSAN GRUP Türkiye Organizasyonu



# TOKSAN GRUP Türkiye Organizasyonu





# TOKSAN GRUP Türkiye Organizasyonu





- ZCCCT & ZCC-grubu 1953'te kuruldu.
  - 150 000 m<sup>2</sup>'den fazla üretim alanı.
  - Dünya çapında 280 milyar € ciro ile %20'si Ar-Ge çalışanı olmak üzere 1500'den fazla çalışan.
  - Yeni ürün ,uç kalitesi ,uç şekli ve ürün gamını geliştirmek için yılda 30'dan fazla Ar-Ge projesi vardır.
  - Dünya çapında 70 ülkeye satış yapmaktadır.
- ***"Fortune 500" Dünyanın En Büyük Firmaları sıralamasında 2011 yılında 228. (Coca Cola 256. sırada idi)***



Wolfram (Wc)  
Titan (Ti)  
Tantal (Ta)  
Cobald (Co)

## Temel Çalışma Alanlarımız:

Ham malzeme geliştirme,

Karbür tozu,

Kesici Uç Harici Karbür Parçalar,

Karbür Kesici uçlar

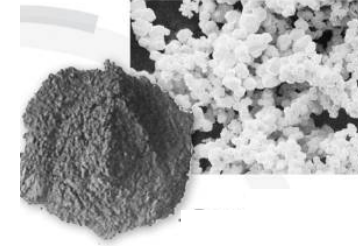

## ZCC Ürün Programı

Torna Grubu Ürünler:



Sert Malzeme Grubu Ürünler:



Diş Çekme Grubu Ürünler:

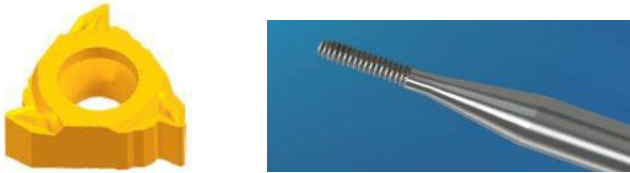

Freze Grubu Ürünler:



Delme Grubu Ürünler:



Kanal Grubu Ürünler:



## C.P.T. Ürün Programı



- CPT 2003'te kuruldu
- Avrupadaki (Almanya Düseldorf) ofislerinden; Asya ve Afrika'nın Satış, Teknik Destek, Tasarım ve Ar-Ge ile Kalite Yönetimini kontrol etmektedir.

• Diş Tornalama,

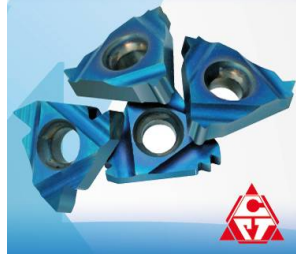

• Karbür Delik Tornalama Takımları

(Tiny Tools)

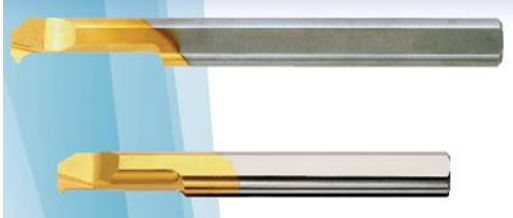

• Diş Frezeleme,

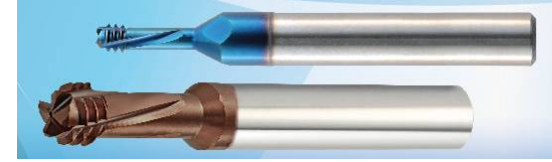

• Tıp Sektörü,



# 100 lerce çeşit seçeneği ile CPT İle Tornada Diş Çekme

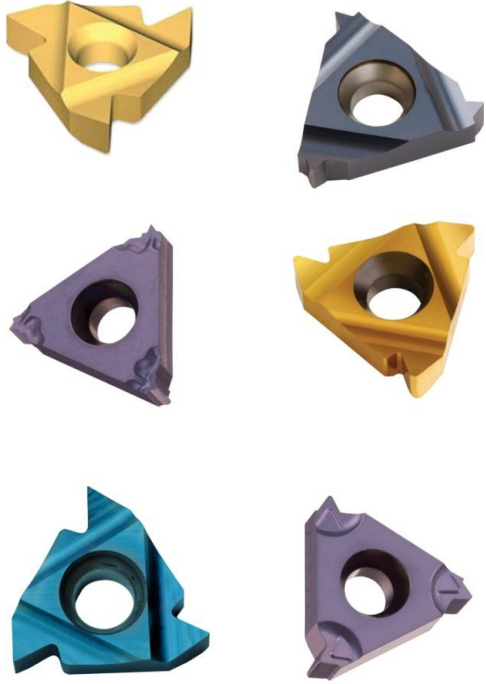

Diş Çap Diş Katerleri



# 100 lerce çeşit seçeneği ile CPT İle Frezede Diş Çekme





# 100 lerce çeşit seçeneği ile CPT İle Frezede Diş Çekme



# CPT Diş Çekme ve Seçme Programı İle Artık İşleriniz Daha Kolay:::

**Carmex**  
Precision Tools Ltd.

**Thread Data**

**Units**  mm  inch

**Standard** ISO

**Pitch** 2 (mm)

**Starts** 1

**Thread** M26 x 2 Fine Thread

**In/Ex** Internal

**Length of Thread Lo** 20

**Major Dia. Do** 26.000

**Pitch Dia. Dp** 24.701

**Minor Dia. Dm** 23.835

**Helix Angle  $\beta$**  1.5°

**Drill Dia.** 23.8

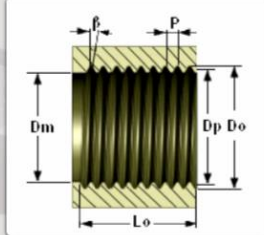
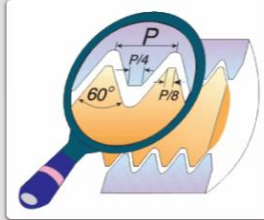

# Özel Ürün seçeneği ile CPT ile Diş Çekme

## Special Tools

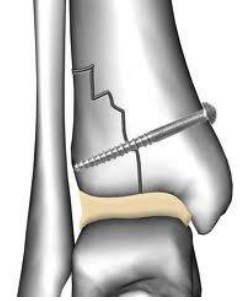

## Tiny Tools-Küçük Karbür Delik Takımları

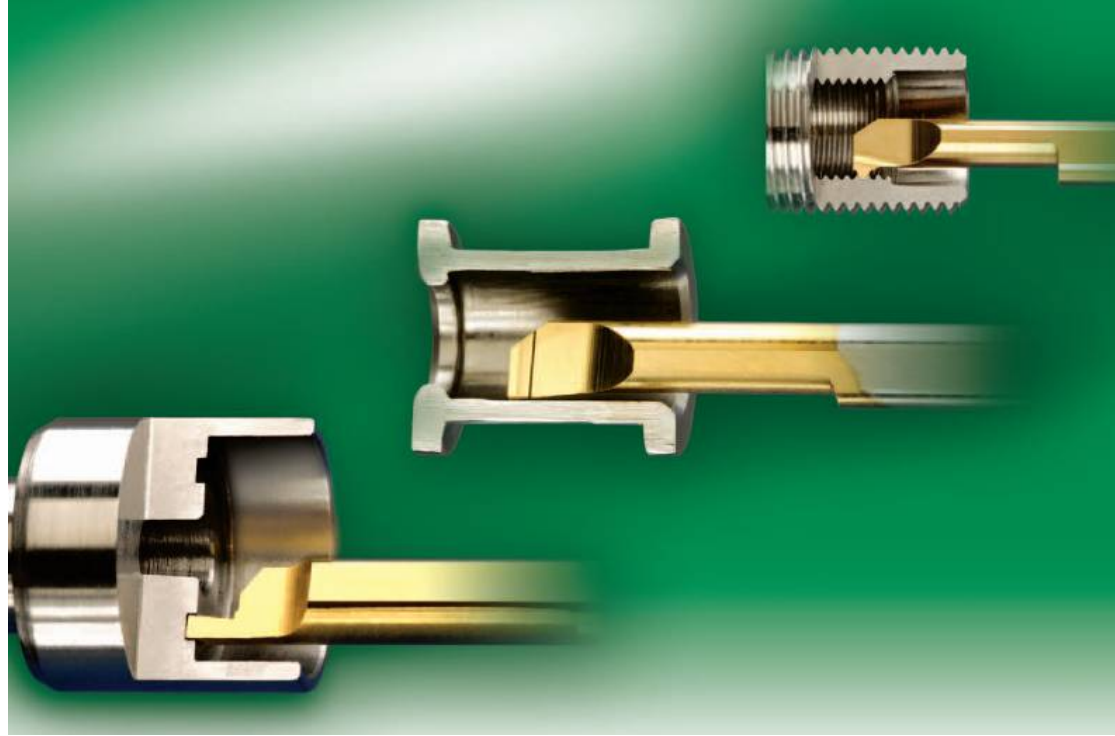

## Tiny Tools-Küçük Karbür Delik Takımları Kullanım Alanları

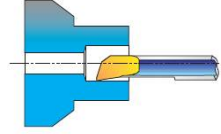

Delik İşleme(MTR)

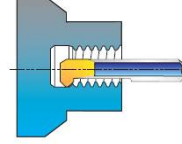

Delik ve kanal işleme(MCR)

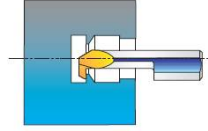

Ters Açılı Tornalama(MXR)

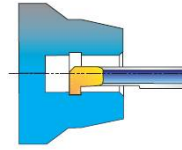

Kanal ve Profil işleme(MGR)

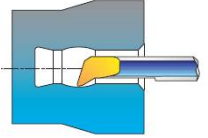

Delik Profil İşleme (MPR)

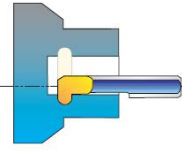

Tam radyüs kanal açma(MKR)

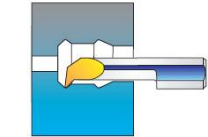

Delik Profil İşleme (MQR)

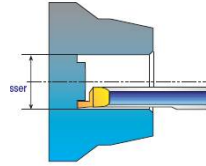

Delik Alın kanal Açma(MFR)

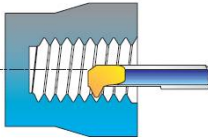

Diş çekme (MIR)

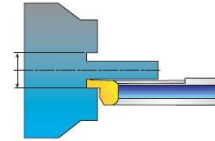

Dip Alın Kanal Açma (MFL)

## Tiny Tools-Küçük Karbür Delik Takımları Tanıtım Kiti,

### Mini Chamfer Kit

Kit KMC	Qty
MC 0303 C12 A90	1
MC 03025 C6 A90	1
MC 0404 C10 A90	1
MC 04035 C9 A90	1
MC 05045 C11 A90	1
MC 0606 C24 A90	1



### Special Solid Carbide Tools



As part of being a service-orientated company,  
Carmex produces specials according to  
customer's requirements.

Special tools are supplied in short delivery times.





## Diş Çekme Yöntemlerinde Alman Efsanesi Neoboss



### Talaşlı Diş Çekme Takımları



### Talaşsız Diş Çekme Takımları



### Ovalama Kılavuzları



Toksan Dış Ticaret Ltd.Şti.

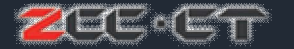



## 100 lerce Kılavuz Grubuyla Kusursuz Diş Çekme İmkani Sağlar- HSS ve KARBÜR kılavuzlar



Toksan Dış Ticaret Ltd.Şti.





**Yes**® YESTOOL Co., Ltd.

## Takma Uçlu 100 lerce Çeşidiyle YES Tool Matkap Grubu



Özel Matkap  
Grubu



Rayba Grubu

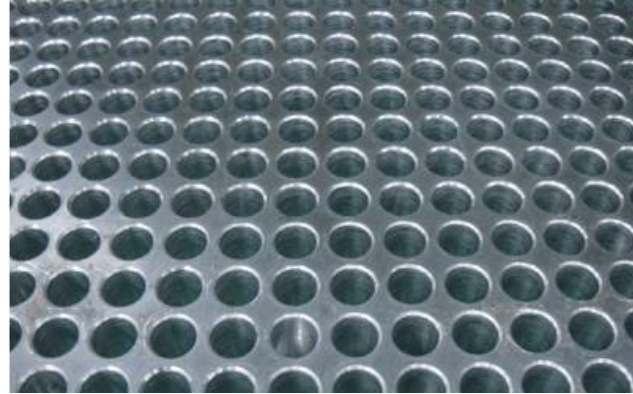

## TUTUCU SİSTEMLERDE 35 YILLIK TÜRK TECRÜBESİ



35 YILLIK  
TECRÜBE



100  
LERCE  
ÇEŞİT



## TAKIM SİSTEMLERİNDE TÜRK KALİTESİ

### Tornada İç&Dış Tüm Katerler



### Tüm Freze Takımları



### Delik Delme&İşleme Takımları





INDUSTRIAL TOOL & SUPPLY COMPANY

# TEŞEKKÜRLER

AKILLI  
FİYAT

HIZLI  
TESLİMAT



Toksan Dış Ticaret Ltd.Şti.

